

20 Watts

- Regulated single outputs from 3.3 to 30VDC
- Wide 4:1 input range
- Chassis mount with optional DIN rail clip
- IEC/UL/cUL 62368-1 safety approvals
- EN55032 class A with no external components
- Remote on/off & voltage trim function
- 3.0kVDC isolation
- Convection cooled
- -40°C to +100°C operating temperature
- Full power to 70°C
- 3 year warranty



Dimensions:

DTE20:

3.78 x 2.13 x 0.92" (96.0 x 54.0 x 23.3 mm)

Models & Ratings

| Input Voltage | Output Voltage | Output Current | Input Current ^(1,4) | | Maximum Capacitive Load | Efficiency ⁽²⁾ | Model Number ⁽³⁾ |
|-------------------|----------------|----------------|--------------------------------|-----------|-------------------------|---------------------------|-----------------------------|
| | | | No Load | Full Load | | | |
| 24 V (9-36 V) | 5.1 V | 4.0 A | 70 mA | 0.94 A | 6800 µF | 90% | DTE2024S5V1 |
| | 12.0 V | 1.67 A | 70 mA | 0.92 A | 1160 µF | 90% | DTE2024S12 |
| | 24.0 V | 0.835 A | 70 mA | 0.92 A | 300 µF | 90% | DTE2024S24 |
| | 48.0 V | 0.42 A | 70 mA | 0.94 A | 75 µF | 89% | DTE2024S48 |
| 48 V (18-75 V) | 5.1 V | 4.0 A | 35 mA | 0.47 A | 6800 µF | 89% | DTE2048S5V1 |
| | 12.0 V | 1.67 A | 35 mA | 0.46 A | 1160 µF | 91% | DTE2048S12 |
| | 24.0 V | 0.835 A | 35 mA | 0.46 A | 300 µF | 92% | DTE2048S24 |
| | 48.0 V | 0.42 A | 35 mA | 0.47 A | 75 µF | 90% | DTE2048S48 |

Notes

1. Input current measured at nominal input voltage.
2. Typical values.
3. For optional version fitted with Din Clip add suffix '-D' e.g. DTE2024S24-D.
4. Input current is typically 3 mA at nominal input voltage when output is remotely turned off.

Mechanical Details

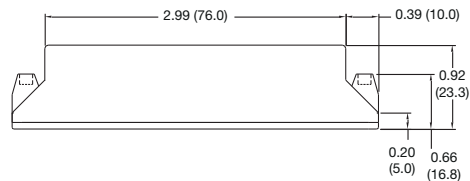
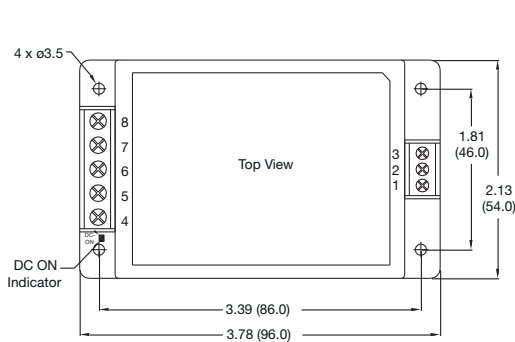

-D Version

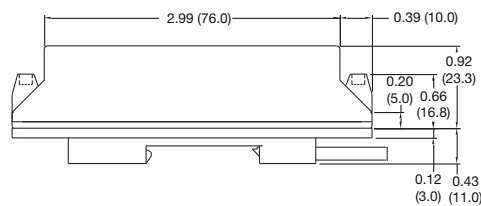

| Pin Connections | |
|-----------------|---------------|
| Pin | Function |
| 1 | Remote On/Off |
| 2 | -Vin |
| 3 | +Vin |
| 4 | No Connection |
| 5 | -Vout |
| 6 | No Connection |
| 7 | +Vout |
| 8 | No Connection |

Notes

1. All dimensions are in inches (mm)
2. Weight: 0.214 lbs (107 g) approx
3. Weight for -D version: 0.332 lbs (166 g) approx
4. Terminal wire size 1.5 mm² max
5. Screw terminal torque 4.5 to 6.2 lb-in (0.5 to 0.7 Nm)
6. Case tolerance: ±0.02 (±0.5)

Input

| Characteristic | Minimum | Typical | Maximum | Units | Notes & Conditions |
|----------------------|---|---------|---------|-------|------------------------------|
| Input Voltage Range | 9 | | 36 | VDC | 24 V nominal |
| | 18 | | 75 | VDC | 48 V nominal |
| Input Current | | | | | See Models and Ratings table |
| Inrush Current | | | | A | |
| Input Filter | Pi type | | | | |
| Undervoltage Lockout | On at >9 V. Off <7.5 V | | | | 24 V models |
| | On at >18 V. Off <16.0 V | | | | 48 V models |
| Input Surge | | | 50 | VDC | 24 V models for 100 ms |
| | | | 100 | VDC | 48 V models for 100 ms |
| Remote On/Off | On: Logic High (3.5-12 V) or open circuit | | | | |
| | Off: Logic Low (<1.2 V) or short pin 1 to pin 2 | | | | |

Output

| Characteristic | Minimum | Typical | Maximum | Units | Notes & Conditions |
|--------------------------|---------|---------|-------------------|-------------|---|
| Output Voltage | 5.1 | | 48 | V | See Models and Ratings table |
| Initial Set Accuracy | | ±1 | ±2 | % | |
| Minimum Load | 0 | | | A | No minimum load required |
| Start Up Delay | | 50 | | ms | |
| Line Regulation | | ±0.5 | | % | |
| Load Regulation | | 1 | | % | 0 - 10% load |
| Transient Response | | | 5 | % deviation | Recovery to within 1% in <250 µs for a 50% load change at 0.25 A/µs rate |
| Ripple & Noise | | | 100 150 200 | mV pk-pk | 5.1 V model, 20 MHz bandwidth 12 V & 48 V models, 20 MHz bandwidth 48 V model, 20 MHz bandwidth |
| Short Circuit Protection | | | | | Trip & Restart (hiccup mode), auto recovery |
| Overload Protection | | 150 | | % | Trip & Restart (hiccup mode) |
| Overvoltage Protection | | 120 | | % | Zener diode clamp |
| Temperature Coefficient | | | 0.02 | %/°C | |

General

| Characteristic | Minimum | Typical | Maximum | Units | Notes & Conditions |
|-----------------------------|---------|-------------|---------|-------------------|------------------------------|
| Efficiency | | 90 | | % | See Models and Ratings table |
| Isolation | 2500 | | | VDC | For 60 s |
| Isolation Resistance | 1000 | | | MΩ | At 500 VDC |
| Input to Output Capacitance | | | 2200 | pF | |
| Switching Frequency | | 285 | | kHz | |
| Power Density | | | 2.7 | W/in ³ | |
| Mean Time Between Failure | 750 | | | kHrs | MIL-HDBK-217F, +25 °C GB |
| Weight | | 0.214 (107) | | lb (g) | |

Environmental

| Characteristic | Minimum | Typical | Maximum | Units | Notes & Conditions |
|--|--|---------|---------|-------|--------------------|
| Operating Temperature | -40 | | +95 | °C | See derating curve |
| Storage Temperature | -50 | | +125 | °C | |
| Case Temperature | | | 95 | °C | |
| Thermal Impedance (Case to Ambient) | 3.9 | | | °C/W | Natural convection |
| | 3.9 | | | | 100 LFM |
| | 3.1 | | | | 200 LFM |
| | 2.5 | | | | 400 LFM |
| Humidity | 5 | | 95 | %RH | Non-condensing |
| Cooling | | | | | Natural convection |
| Shock | ±3 shocks in each plane, total 18 shocks of 30 g : 11 ms halfsine. Conforms to EN60068-2-27 & EN60068-2-47 | | | | |
| Vibration | 10-500 Hz at 2 g sweep and endurance at resonance in all 3 planes. Conforms to EN60068-2-6 | | | | |

EMC: Emissions

| Phenomenon | Standard | Test Level | Notes & Conditions |
|------------|----------|------------|-----------------------------|
| Conducted | EN55032 | Level A | With no external components |
| Radiated | EN55032 | Level A | See application notes |

EMC: Immunity

| Phenomenon | Standard | Test Level | Criteria | Notes & Conditions |
|--------------------|-------------|--------------------------|----------|--------------------|
| Immunity | EN55024 | | | |
| ESD Immunity | EN61000-4-2 | ±4 kV Contact, ±8 kV Air | A | |
| Radiated Immunity | EN61000-4-3 | 10 V/m | A | |
| EFT/Burst | EN61000-4-4 | 3 | A | |
| Surges | EN61000-4-5 | 3 | A | |
| Conducted Immunity | EN61000-4-6 | 10 Vm | A | |
| Magnetic Fields | EN61000-4-8 | 30 A/m | A | |

Safety Approvals

| Safety Agency | Safety Standard | Notes & Conditions |
|---------------|-----------------|--------------------|
| CB | IEC60950-1 | ITE |
| UL | UL60950-1 | ITE |

Application Notes

Derating Curve for Convection Cooling

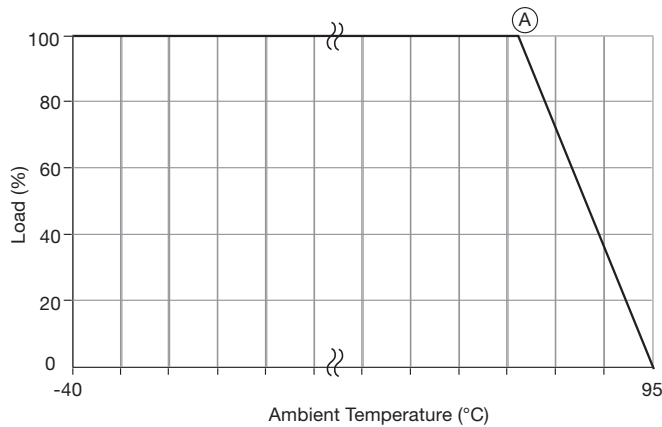

- Ⓐ : 87°C for DTE2024S12, S24
DTE2048S12, S24
- : 86°C for DTE2024S5V1
DTE2048S5V1
- : 85°C for DTE2024S48
DTE2048S48

Radiated Emissions

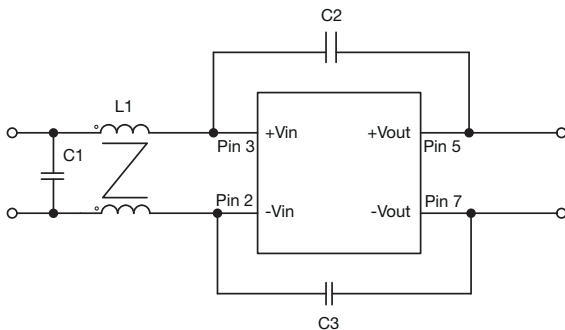

| Model | L1 | C1 | C2 | C3 |
|------------|-------------|-------------------|-------------|-------------|
| DTE2024SXX | 120 μ H | 4.7 μ F/50 V | None | 220 pF/3 KV |
| DTE2048SXX | 120 μ H | 3.3 μ F/100 V | 220 pF/3 KV | 220 pF/3 KV |

Mechanical Details

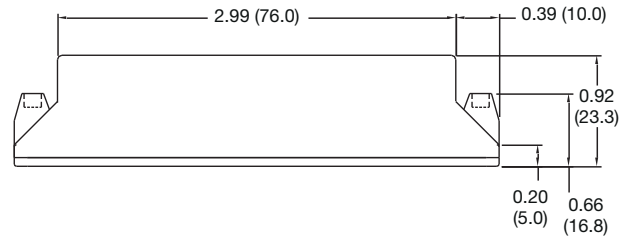
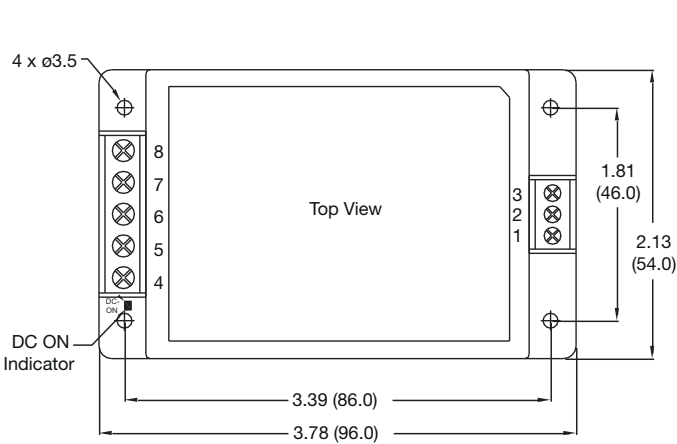

-D Version

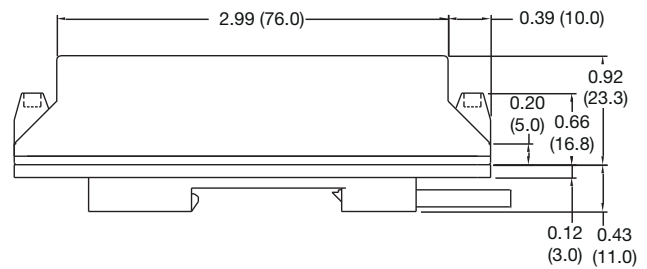

Notes

1. All dimensions are in inches (mm)
2. Weight: 0.214 lbs (107 g) approx
3. Weight for -D version: 0.332 lbs (166 g) approx
4. Terminal wire size 1.5 mm² max
5. Screw terminal torque 4.5 to 6.2 lb-in (0.5 to 0.7 Nm)
6. Case tolerance: ±0.02 (±0.5)

| Pin Connections | |
|-----------------|---------------|
| Pin | Function |
| 1 | Remote On/Off |
| 2 | -Vin |
| 3 | +Vin |
| 4 | No Connection |
| 5 | -Vout |
| 6 | No Connection |
| 7 | +Vout |
| 8 | No Connection |