

750 Watts

- 200 - 425 VDC Input Range
- Single Output
- Industry Standard Full Brick
- -40 °C to +85 °C Operation
- 3000 VAC Isolation Reinforced
- Output Trim -40% to +10%
- Remote On/Off
- Current Share and Power Good Signals
- 3 Year Warranty

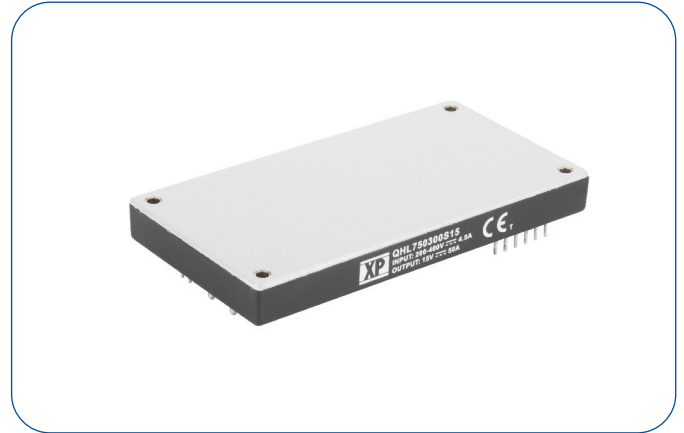

Dimensions:

QHL750:

4.6 x 2.4 x 0.5" (116.8 x 61.0 x 12.7 mm)

The QHL750 extends the product range of high voltage input DC-DC modules to 750W in an full brick module. This series of modules enables effective construction of distributed power architectures from AC front ends, PFC front ends and from battery systems.

Models & Ratings

Input Voltage	Output Voltage	Output Current	Input Current ⁽¹⁾		Ripple & noise ⁽²⁾	Efficiency ⁽¹⁾	Max. capacitive load ⁽³⁾	Model Number
			No Load	Full Load				
200-425 V	12 V	62.5 A	10 mA	2.79 A	300 mV	89.5%	10000 µF	QHL750300S12
	15 V	50.0 A	10 mA	2.81 A	300 mV	89.0%	10000 µF	QHL750300S15
	24 V	31.2 A	10 mA	2.78 A	400 mV	90.0%	10000 µF	QHL750300S24
	28 V	26.7 A	10 mA	2.73 A	400 mV	90.5%	10000 µF	QHL750300S28
	48 V	15.6 A	10 mA	2.75 A	650 mV	91.0%	8000 µF	QHL750300S48

Notes

1. Measured at 300 VDC input.
2. Peak to peak measured at 20MHz bandwidth and 1000 µF electrolytic/1 µF ceramic capacitors.
3. Minimum capacitive load of 1000 µF required to maintain regulation.

Mechanical Details

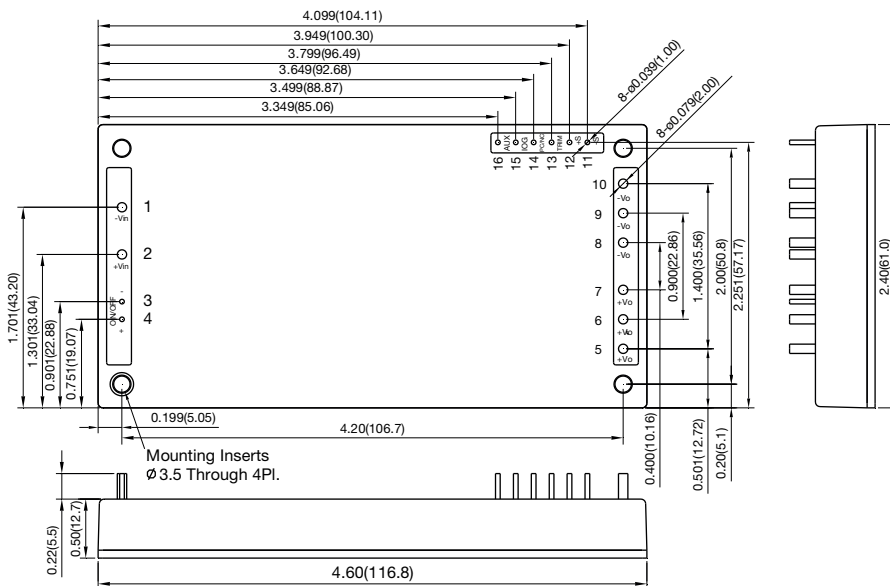

Pin Connections	
Pin	Function
1	-Vin
2	+Vin
3	REM-
4	REM+
5-7	+Vout
8-10	-Vout
11	-Sense
12	+Sense
13	Trim
14	Current Share
15	Power Good
16	Auxiliary, 7-13 V/20 mA

Notes

1. All dimensions are in inches (mm)
2. Weight: 0.51 lbs (230 g) approx.
3. Tolerance: x.xx = ±0.02 (x.x = ±0.5)
x.xxx = ±0.01 (x.xx = ±0.25)

Input

Characteristic	Minimum	Typical	Maximum	Units	Notes & Conditions
Input Voltage Range	200		425	VDC	
Input Current	1.8		3.9	A	200-425VDC input
Input Surge			475	VDC	For 100 ms
Undervoltage Lockout	>185 V	190	195	VDC	On
	<175 V	480	185		Off
Lockout Hysteresis		10		VDC	
Input Transient Voltage			475	VDC	For 100 ms
Input Overvoltage Lockout		480/500		VDC	Module On / Module Off
Idle Current		10		mA	When output is remotely turned off
Inrush Current			0.1	A ² s	
Recommended Input Fuse		10		A	Fast acting type
Input Reflected Ripple Current			50	mA pk-pk	Through 10 μ H inductor

Output

Characteristic	Minimum	Typical	Maximum	Units	Notes & Conditions
Output Voltage	12		48	VDC	See Models and Ratings table
Output Trim	-40		+10	%	See Application Note
Initial Set Accuracy			± 1.0	%	At full load and 36 V input
Minimum Load	0			%	No minimum load required
Line Regulation			± 0.2	%	From minimum to maximum input at full load
Load Regulation			± 0.5	%	From 0% to full load
Transient Response		± 3.0	± 5.0	%	Maximum deviation, recovering to less than 1% in 500 μ s for 25% step load change.
Start Up Time			700	ms	
Output Voltage Rise Time		40		ms	
Ripple & Noise				mV pk-pk	See models and ratings table
Overload Protection	105		125	%	
Short Circuit Protection					Continuous hiccup mode, with auto recovery
Maximum Capacitive Load					See Models and Ratings table. Minimum capacitance of 1000 μ F required to meet specified regulations
Temperature Coefficient			0.03	%/°C	
Overvoltage Protection	115	125	140	%	
Remote On/Off	Output is on if REM+ (pin 4) is open or high (3.5-75 VDC) with respect to REM- (pin 3) or -Vin (positive logic) Output turns off if REM+ (pin 4) is low (<1.2 VDC max) with respect to REM- (pin 3) or -Vin (see application notes)				

General

Characteristic	Minimum	Typical	Maximum	Units	Notes & Conditions
Efficiency		90		%	See Models and Ratings table
Isolation: Input to Output	3000			VAC	60 s reinforced
Isolation: Input to Case	2500			VAC	60 s
Isolation: Output to Case	500			VAC	60 s
Switching Frequency		200		kHz	Fixed, $\pm 15\%$
Isolation Resistance	10 ⁹			Ω	
Power Density			135	W/in ³	
Mean Time Between Failure		370		kHrs	MIL-HDBK-217F, +25 °C GB
Pin Material	Copper with nickel and matte tin plating				
Case Material	Plastic (DAP) with aluminium, UL94V-0				
Potting Material	Epoxy, UL94V-0				
Solder Profile	260°C max. Above 250°C. 3-6s				With iron 450°C for <5s
Water Wash	Use deionized water, do not soak. Dry thoroughly				
Weight		0.51 (230.0)		lb (g)	

Environmental

Characteristic	Minimum	Typical	Maximum	Units	Notes & Conditions
Operating Base Plate Temperature	-40		+85	°C	
Storage Temperature	-55		+105	°C	
Thermal Protection		+95		°C	Auto recovery at 75 °C typical
Humidity			95	%RH	Non-condensing
Altitude			2000	m	Operating. Storage to 12000m
Cooling					Baseplate-cooled

EMC: Emissions

Phenomenon	Standard	Test Level	Notes & Conditions
Conducted	EN55032	Class A	See Application Notes
Radiated	EN55032	Class A	

EMC: Immunity

Phenomenon	Standard	Test Level	Criteria	Notes & Conditions
ESD Immunity	EN61000-4-2	±4 kV/±8 kV	A	Contact Discharge/Air Discharge
Radiated Immunity	EN61000-4-3	3 V rms	A	
EFT/Burst	EN61000-4-4	1 kV	A	Requires VZ1, VZ2, GT1 & GT2 as shown in conducted emission circuit
Surge	EN61000-4-5	0.5 kV	A	Requires VZ1, VZ2, GT1 & GT2 as shown in conducted emission circuit
Conducted Immunity	EN61000-4-6	3 V rms	A	
Magnetic Fields	EN61000-4-8	3 A/m	A	

Mechanical Details

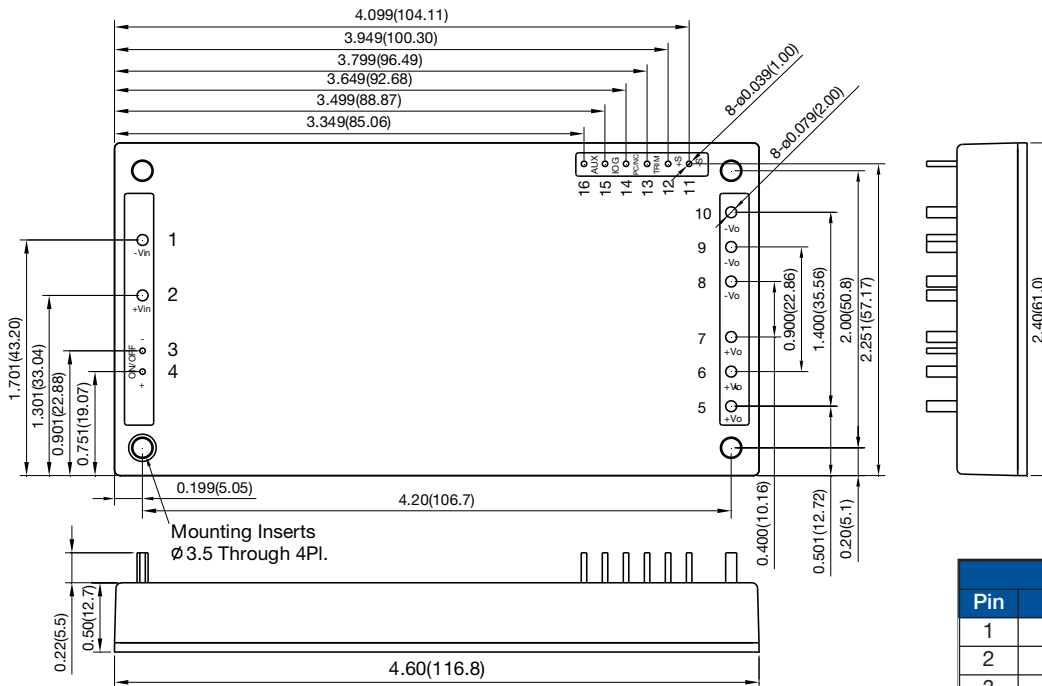

Pin Connections	
Pin	Function
1	-Vin
2	+Vin
3	REM-
4	REM+
5-7	+Vout
8-10	-Vout
11	-Sense
12	+Sense
13	Trim
14	Current Share
15	Power Good
16	Auxiliary, 7-13 V/20 mA

Notes

- All dimensions are in inches (mm)
- Weight: 0.51 lbs (230 g) approx.

- Tolerance: x.xx = ±0.02 (x.x = ±0.5)
x.xxx = ±0.01 (x.xx = ±0.25)

Application Notes

Input Fusing and Safety Considerations

The QHL750 series converters have no internal fuse. In order to achieve maximum safety and system protection, always use an input line fuse. We recommended a 30 A fast acting fuse. It is also recommended that the circuit has a transient voltage suppressor diode (TVS) across the input terminals to protect the unit against surge or spike voltages and input reverse voltage (as shown). A suitable part would be SMCJ78A.

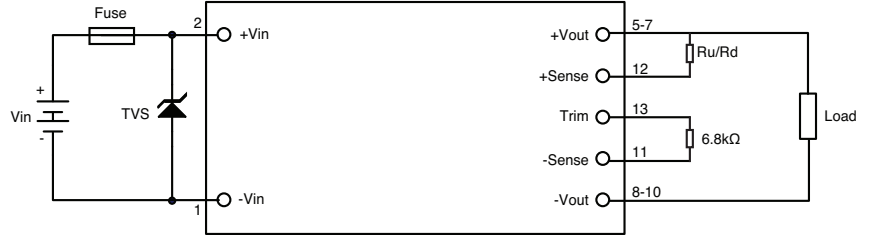

Output Voltage Adjustment

The Trim input permits the user to adjust the output voltage up by 10% or down by 40%. This is accomplished by connecting a mandatory external resistor between the Trim pin and negative sense pin of value 6.8kOhm. Then select Ru or Rd to determine desired output voltage.

To Trim Down (Rd)

Trim Down %	12 V	15 V	24 V	28 V	48 V
	Rtrim_down (kΩ)				
1	10.63	13.29	21.26	24.80	42.51
2	10.40	13.00	20.80	24.27	41.60
3	10.17	12.71	20.34	23.73	40.69
4	9.943	12.43	19.89	23.20	39.77
5	9.714	12.14	19.43	22.67	38.86
6	9.486	11.86	18.97	22.13	37.94
7	9.257	11.57	18.51	21.60	37.03
8	9.029	11.29	18.06	21.07	36.11
9	8.800	11.00	17.60	20.53	35.20
10	8.571	10.71	17.14	20.00	34.29
11	8.343	10.43	16.69	19.47	33.37
12	8.114	10.14	16.23	18.93	32.46
13	7.886	9.857	15.77	18.40	31.54
14	7.657	9.571	15.31	17.87	30.63
15	7.429	9.286	14.86	17.33	29.71
16	7.200	9.000	14.40	16.80	28.80
17	6.971	8.714	13.94	16.27	27.89
18	6.743	8.429	13.49	15.73	26.97
19	6.514	8.143	13.03	15.20	26.06
20	6.286	7.857	12.57	14.67	25.14
21	6.057	7.571	12.11	14.13	24.23
22	5.829	7.286	11.66	13.60	23.31
23	5.600	7.000	11.20	13.07	22.40
24	5.371	6.714	10.74	12.53	21.49
25	5.143	6.429	10.29	12.00	20.57
26	4.914	6.143	9.829	11.47	19.66
27	4.686	5.857	9.371	10.93	18.74
28	4.457	5.571	8.914	10.40	17.83
29	4.229	5.286	8.457	9.867	16.91
30	4.000	5.000	8.000	9.333	16.00
31	3.771	4.714	7.543	8.800	15.09
32	3.543	4.429	7.086	8.267	14.17
33	3.314	4.143	6.629	7.733	13.26
34	3.086	3.857	6.171	7.200	12.34
35	2.857	3.571	5.714	6.667	11.43
36	2.629	3.286	5.257	6.133	10.51
37	2.400	3.000	4.800	5.600	9.600
38	2.171	2.714	4.343	5.067	8.686
39	1.943	2.429	3.886	4.533	7.771
40	1.714	2.143	3.429	4.000	6.857

To Trim Up (Ru)

Trim Up %	12 V	15 V	24 V	28 V	48 V
	Rtrim_up (kΩ)				
1	11.09	13.86	22.17	25.87	44.34
2	11.31	14.14	22.63	26.40	45.26
3	11.54	14.43	23.09	26.93	46.17
4	11.77	14.71	23.54	27.47	47.09
5	12.00	15.00	24.00	28.00	48.00
6	12.23	15.29	24.46	28.53	48.91
7	12.46	15.57	24.91	29.07	49.83
8	12.69	15.86	25.37	29.60	50.74
9	12.91	16.14	25.83	30.13	51.66
10	13.14	16.43	26.29	30.67	52.57

Power Good Signal

Open collector output, referenced to -Sense Pin. Output is pulled low if DC/DC is operating normally and floating if DC/DC is remotely turned off or operating abnormally.

Application Notes

Thermal Resistance Information

Airflow Derating Graph - Without Heatsink

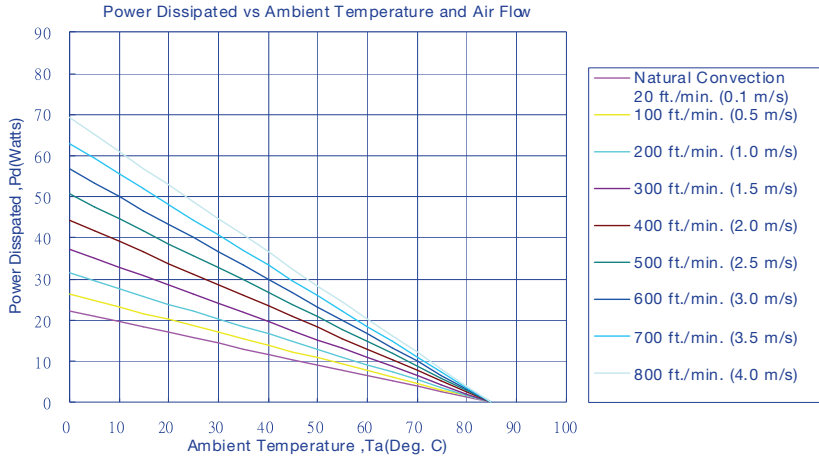

Air Flow Rate	Typical Rca
Natural Convection 20 ft/min (0.1 m/s)	3.82 °C/W
100 ft/min (0.5 m/s)	3.23 °C/W
200 ft/min (1.0 m/s)	2.71 °C/W
300 ft/min (1.5 m/s)	2.28 °C/W
400 ft/min (2.0 m/s)	1.92 °C/W
500 ft/min (2.5 m/s)	1.68 °C/W
600 ft/min (2.5 m/s)	1.50 °C/W
700 ft/min (2.5 m/s)	1.35 °C/W
800 ft/min (2.5 m/s)	1.23 °C/W

Example (Without Heatsink)

To determine the minimum airflow necessary for a QHL750300S48 operating at an input voltage of 300 V, an output current of 11A, and a maximum ambient temperature of 25°C:

Determine Power dissipation (Pd): $Pd = Pi - Po = Po(1-\eta)/\eta$,

$$Pd = 48V \times 11A \times (1-0.91) / 0.91 = 47.47$$

Where Pi = Input power, Po = Output Power and η = Efficiency

Determine airflow from airflow derating graph using data points for Pd = 47.4 W and Ta = 25°C

Minimum airflow= 800 ft./min.

To check that the maximum case temp of 85°C is not exceeded:

Maximum temperature rise is

$$\Delta T = Pd \times Rca = 47.47 \times 1.23 = 58.38^\circ C.$$

Maximum case temperature is

$$Tc = Ta + \Delta T = 83.38^\circ C < 85^\circ C.$$

Where: Rca is the thermal resistance from case to ambient environment. Ta is ambient temperature and Tc is case temperature.

Remote Control

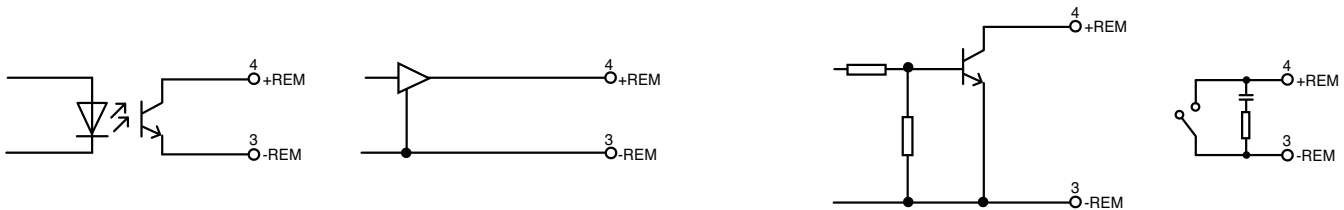

Application Notes

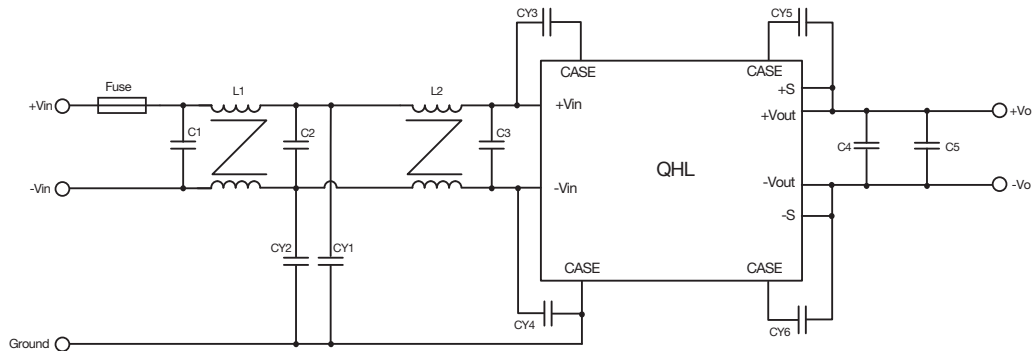

Model Number	C1	C2	C3	C4	C5	CY1	CY2	CY3	CY4	CY5	CY6	L1	L2
QHL750300Sxx	0.68 μ F/ 305 V	0.68 μ F/ 305 V	150 μ F/ 450 V	820 μ F/ 63V	1 μ F/ 100V	3300 pF	3300 pF	4700 pF	4700 pF	2200 pF	3300 pF	4.2 mH	4.2 mH

Notes

C1, C2, C3: metallized polypropylene film capacitors

C6: aluminum capacitor

C9, CY1, CY2, CY3, CY4, CY5, CY6: ceramic capacitors.

C1, C2: 0.68 μ F/305V (FARATRONIC MKP62 Series C42Q2684M6HC000) or equivalent.

C3: 150 μ F/450V (NIPPON CHEMI-CON KMR Series EKMR451VSN331MR35S) or equivalent.

C4: 820 μ F/63V (Rubycon ZLH Series 63ZLH820MEFC16X25) or equivalent.

C5: 1 μ F/100 V SMD 1210 (TDK CGA Series CGA8N2X7R2A105K230KA) or equivalent.

L1, L2:

4.2 mH (VAKOS T25*15*13 R8K Series 0.8 mm/20T) or equivalent.

CY1, CY2, CY3, CY4, CY5, CY6, C5:

2200 pF (MURATA KX Series DC1B3KX222MA4BN01F) or equivalent.

3300 pF (MURATA KX Series DC1B3KX332MA4BN01F) or equivalent.

4700 pF (MURATA KX Series DC1B3KX472MA4BN01F) or equivalent.

10000 pF (TDK CS Series CS17-F2GA103MYAS) or equivalent.

Ground Connection

The above circuit assumes an earth connection is available. If no earth present CY capacitors should be connected to case as shown. CY values might require adjustment depending on the application. Please consult XP applications engineering for further support.

Safety Considerations

The use of a fuse on the input line is recommended for good practice. Additional protection for surges and reverse voltage are also recommended. Transient voltage suppressors and gas discharge devices can be fitted across the input terminals.

Series & Parallel Configurations

Please contact XP applications engineering for further details.