

3 Watts

- Compact PCB mount SIL package
- Encapsulated & open frame versions
- ITE & household appliance approvals
- Class II operation
- Input range 85 to 305VAC
- Single outputs from 3.3 to 48VDC
- No load input power <0.3W
- Low cost
- -25°C to +70°C operating temperature
- 3 year warranty

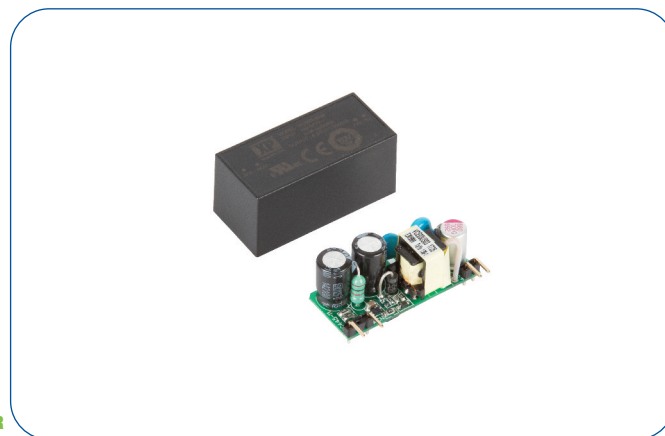

Dimensions:

VCE03:
1.60 x 0.75 x 0.75" (40.6 x 19.10 x 19.10 mm)
VCE03-P:
1.50 x 0.65 x 0.65" (38.1 x 16.5 x 16.5 mm)

The VCE03 is a series of open frame and encapsulated AC-DC single output power supplies designed for low cost ITE industrial and domestic applications. The series provides two mechanical options including open frame and encapsulated PCB mount. With approvals to world-wide safety standards including ITE and household, compliance with class B for conducted and radiated emissions, these class II isolation parts benefit system designers with easy integration into a wide range of applications.

Models & Ratings

Output Power	Output Voltage	Output Current	Model Number ⁽¹⁾
3 W	3.3VDC	910 mA	VCE03US03
3 W	5.0VDC	600 mA	VCE03US05
3 W	9.0VDC	333 mA	VCE03US09
3 W	12.0VDC	250 mA	VCE03US12
3 W	15.0VDC	200 mA	VCE03US15
3 W	24.0VDC	125 mA	VCE03US24
3 W	48.0VDC	63 mA	VCE03US48

Notes

1. For Open Frame version add suffix -P to model number, e.g. VCE03US12-P.

Summary

Characteristic	Minimum	Typical	Maximum	Units	Notes & Conditions
Input Voltage Range	85		305	VAC	Derate from 100% at 90 VAC to 90% at 85 VAC
No Load Input Power			0.3	W	
Efficiency		80		%	Model dependent
Operating Temperature	-25		+70	°C	Derate linearly from 100% at +50 °C to 50% at +70 °C
EMC	EN55032 Level B Conducted & Radiated, EN61000-3-2, EN61000-3-3, EN55024				
Safety Approvals	IEC62368-1, IEC60335-1, IEC60950-1, EN62368-1, EN60335-1, UL62368-1				

Input

Characteristic	Minimum	Typical	Maximum	Units	Notes & Conditions
Input Voltage Range	85		305	VAC	Covers all standard voltages in range from 100 VAC to 277 VAC
Input Frequency	47		63	Hz	
Input Current - Full Load		0.10/0.06/0.04		A rms	At 115/230/277 VAC
No Load Input Power			0.3	W	
Inrush Current			40/44.2	A	At 230/277 VAC, cold start 25 °C
Earth Leakage Current					Class II construction no earth
Input Protection	External T1.0 A/300 VAC fuse required in line				

Output

Characteristic	Minimum	Typical	Maximum	Units	Notes & Conditions
Output Voltage	3.3		48	VDC	
Initial Set Accuracy			2/1	%	At 50% load for 3.3 & 5 V models/Other models
Minimum Load	0			A	No minimum load required
Total Regulation			5/3	%	For 3.3 & 5 V models/Other models: from 10% to 100% load. Includes initial set accuracy, line and load regulation. Total regulation is 7% max from 0% to 100% load.
Start Up Delay			2	s	
Start Up Rise Time			30	ms	
Hold Up Time	16	20		ms	at full load and 115 VAC
Transient Response			4	%	Deviation, recovery within 1% in less than 500 μ s for a 25% load change
Ripple & Noise			180/120	mV pk-pk	3.3 & 5V/9 V models, 20 MHz bandwidth
			1	% pk-pk	12 V to 48 V models, 20 MHz bandwidth
Overvoltage Protection	115		140	% Vnom	210% typical for 3.3 V models, auto recovery
Overload Protection	130		170	%	
Short Circuit Protection					Trip & Restart (hiccup mode)
Temperature Coefficient			0.02	%/°C	

General

Characteristic	Minimum	Typical	Maximum	Units	Notes & Conditions
Efficiency		80		%	At 115 VAC, Model Dependent
Isolation: Input to Output	3000			VAC	
Switching Frequency	5		52	kHz	Varies with load
Power Density			4.7	W/in ³	For '-P' version
Mean Time Between Failure	400			kHrs	MIL-HDBK-217F, +25 °C GB
Weight		0.025 (11)		lb (g)	Open frame versions (-P)
		0.067 (30)		lb (g)	Encapsulated version

Efficiency Graphs

VCE03US12-P

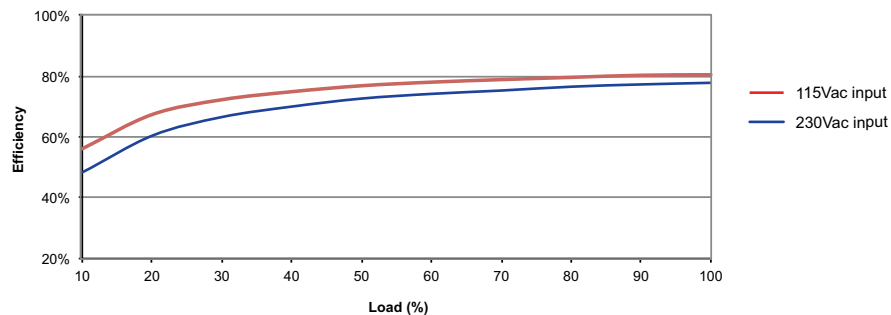

VCE03US24-P

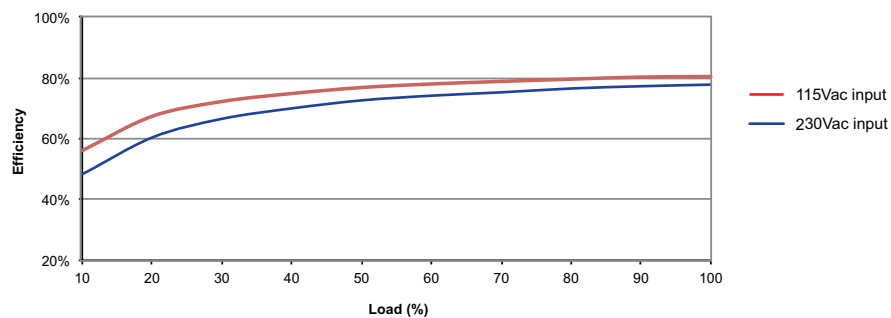

Environmental

Characteristic	Minimum	Typical	Maximum	Units	Notes & Conditions
Operating Temperature	-25		+70	°C	Derate linearly from 100% at +50 °C to 50% at +70 °C
Storage Temperature	-40		+85	°C	
Cooling					Convection-cooled
Humidity			95	%RH	Non-condensing
Operating Altitude			3048	m	
Shock	IEC68-2-27, 30 g, 11 ms half sine, 3 times in each of 6 axes				
Vibration	IEC68-2-6, 2 g, 10 Hz to 500 kHz, 10 mins/cycle, 60 mins each cycle				

EMC: Emissions

Phenomenon	Standard	Test Level	Criteria	Notes & Conditions
Conducted	EN55032	Class B		If output is connected to a ground additional external components will be required. Contact sales for details
Radiated	EN55032	Class B		
Harmonic Current	EN61000-3-2			Class A
Voltage Flicker	EN61000-3-3			

EMC: Immunity

Phenomenon	Standard	Test Level	Criteria	Notes & Conditions
ESD	EN61000-4-2	±6kV contact, ±8kV air discharge	A	
Radiated	EN61000-4-3	10 V/m	A	
EFT	EN61000-4-4	3	A	
Surge	EN61000-4-5	2	A	Line to Line
Conducted	EN61000-4-6	10 Vrms	A	
Magnetic Fields	EN61000-4-8	30 A/m	A	
Dips and Interruptions	EN61000-4-11 (115 VAC)	70% U _r (80.5 VAC) for 100 ms	A	A at High Line, B at Low Line
		40% U _r (46 VAC) for 200 ms	B	
		<5% U _r (0 VAC) for 10 ms	A	
		<5% U _r (0 VAC) for 5000 ms	B	
	EN61000-4-11 (230 VAC)	70% U _r (161 VAC) for 100 ms	A	
		40% U _r (92 VAC) for 200 ms	A	
<5% U _r (0 VAC) for 10 ms		A		
		<5% U _r (0 VAC) for 5000 ms	B	

Safety Approvals

Safety Agency	Safety Standard	Notes & Conditions
CB	IEC60950-1	ITE
	IEC62368-1	
	IEC60335-1	Household, Encapsulated Version
	IEC61558-1	Power Supply Units
UL	UL62368-1	ITE
TUV	EN62368-1	

Mechanical Details

Encapsulated

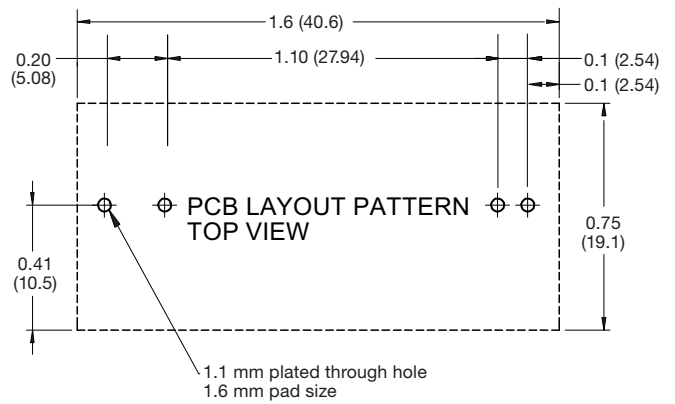
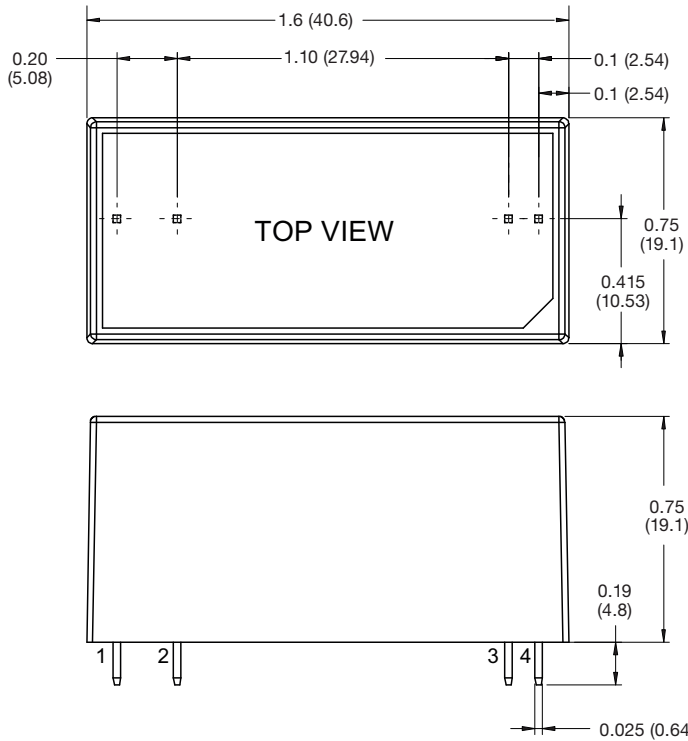

Pin Connections	
Pin	Single
1	ACL
2	ACN
3	+Vout
4	-Vout

Open Frame (-P)

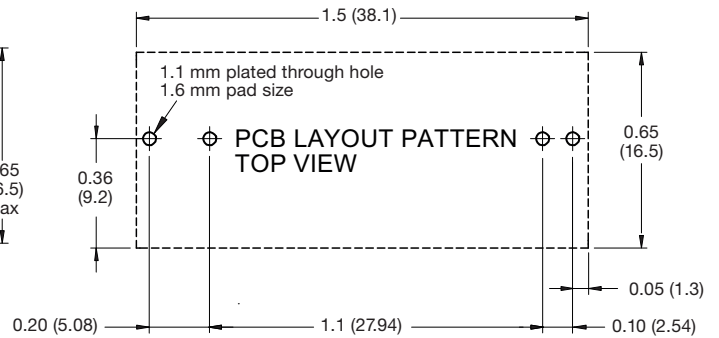
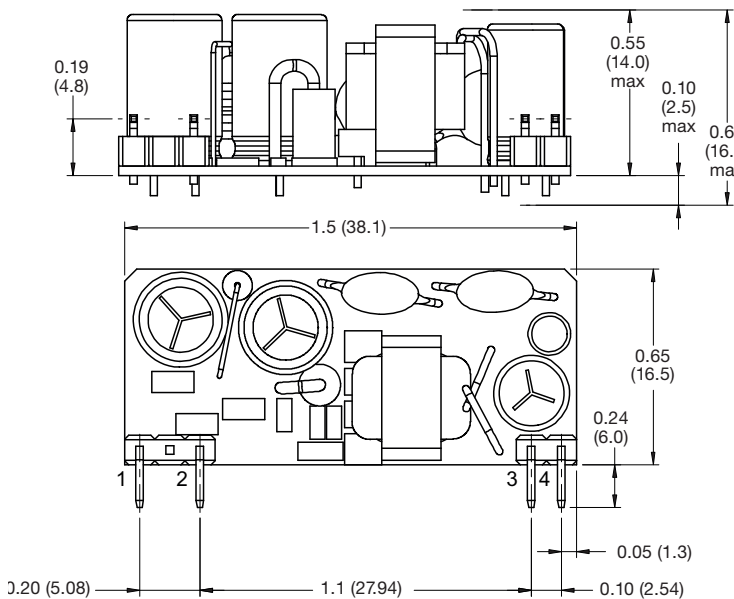

Notes

- Dimensions in inches (mm).
- Weight: Open frame versions (-P): 0.025 lbs (10 g)
Encapsulated: 0.067 lbs (30 g)

- Tolerances: x.xx = ± 0.02 (x.x = ± 0.5)
x.xxx = ± 0.01 (x.xx = ± 0.25)